

CITY OF WINNEMUCCA PUBLIC WORKS MANUAL
SECTION A: STREET IMPROVEMENTS

General Notes:

1) All construction shall be in conformance with the latest edition of the “**Standard Specifications for Public Works Construction**” (commonly referred to as the “orange book”), and the “**Standard Details for Public Works Construction**” as published by Washoe County RTC (et al) unless specifically modified in writing by the City.

2) Listed below are some of the more common requirements/specifications used on street projects for easy reference by the public, developers and contractors:

Trench Excavation and Backfill:

Materials: Refer to Section 200.03 of the Standard Specifications.

Construction: Refer to Section 305 of the Standard Specs.

Maximum backfill lift shall be 12 inches.

Required compaction in streets: 95 %.

Concrete Slurry required on all collector streets (see Section 202.02).

Aggregate Base:

Materials: Refer to Section 200.01 of the Standard Specs.

Type 2, Class B aggregate base (depth is as specified in the latest applicable street section).

Construction: Refer to Section 308 of the Standard Specifications.

Compaction must be at 95% of maximum dry density.

Plantmix Bituminous Pavement:

Materials: Refer to Section 200.02 and 201.05 (Table VII) of the Standard Specs:

Aggregate: **Type 2 Aggregate** that is thoroughly dried and free from all dust or clay coatings and made from 100% crushed aggregate fines.

Asphalt Cement: Polymerized Asphalt: **AC-20P, PG 64-28** at 6-7 percent, or as specified in approved mix design.

Additives: **Hydrated lime** (mineral filler): Minimum of 1 ½ % (or as specified in approved mix design) and marinated in stockpile at least 48 hours. An **anti-stripping agent** may be approved by the City Engineer if submitted in an acceptable mix design.

Construction: Refer to Section 320 of the Standard Specs:

A pre-approved **mix design** less than 12 months old is required.

The maximum asphalt lift thickness shall be 3-inches. Thicker sections must be placed in two equal lifts.

Testing shall be done to determine whether the required compaction is obtained and the **mitigation measures** found in section 320.07 - .09 of the Standard Specifications will be strictly enforced.

Minimum air and ground temperature is 40 F (45 F w/2" or less thickness).

Breakdown roller minimum asphalt temperature is 265 F to 320 F.

Asphalt Tack Coat:

Materials: Refer to Section 201 of the Standard Specs:

CSS-1h.

Construction: Refer to Section 316 of the Standard Specs:

Spread Rate of 0.10 to 0.15 gallons per square yard.

Asphalt Fog Seal:

Materials: Refer to Section 201 of the Standard Specs:

CSS-1h diluted 50:50 with water.

Construction: Refer to Section 317 of the Standard Specs:

Spread rate of 0.10 to 0.20 gallons of diluted material per square yard. Required on all new streets within thirty days of paving completion.

Asphalt Sand Seal:

Materials: Refer to Section 201 of the Standard Specs:

CRS-1 or CRS-2 (asphalt emulsion).

Construction: Refer to Section 317 of the Standard Specs:

Spread rate of 0.15 to 0.20 gallons per square yard with sand at 10 to 15 pounds per square yard. Must be rolled immediately with a pneumatic tire roller and swept after 24 hours.

Asphalt Chip Seal:

Materials: Refer to Section 201 of the Standard Specs:

CRS-2 (asphalt emulsion) with 2 to 2 ½ % latex with clean/washed 3/8 inch chips.

Construction: Refer to Section 317 of the Standard Specs:

Spread rate of 0.35 to 0.45 gallons per square yard with chips at 20 pounds per square yard. Must be rolled immediately with a pneumatic tire roller and lightly swept after 4 hours.

Slurry Seal:

Materials:

Refer to Section 200.02.05 of the Standard Specs: **Type 2 Aggregate.**

Refer to Section 201 of the Standard Specs: **CQS-1h** with latex modified polymer additive at a rate of 3.0%. A pre-approved mix design less than one year old is required.

Construction: Refer to Section 318 of the Standard Specs: Spread rate of 12 pounds per square yard.

Concrete Curb and Gutter:

Materials: Refer to Section 202 of the Standard Specs.

The concrete shall be a **six sack mix** with fiber mesh with a one inch to four inch slump and four to seven percent air entrainment. The compressive strength shall be a minimum of **4,000 psi** after 28 days.

Construction: Refer to Section 312 of the Standard Specs:

Type 1 Curb and Gutter required.

All curbs and gutters shall have ½" expansion joints every 150 feet and at all curb returns and structures. Weakened plane joints shall be placed every ten feet.

Concrete Sidewalks:

Materials: Refer to Section 202 of the Standard Specs.

The concrete shall be a **six sack mix** with fiber mesh with a one inch to four inch slump and four to seven percent air entrainment. The compressive strength shall be a minimum of **4,000 psi** after 28 days.

Construction: Refer to Section 312 of the Standard Specs:

All sidewalks shall have ½" expansion joints every 50 feet and at all curb returns and structures. Weakened plane joints shall be placed every ten feet. Pedestrian ramps are required at all curb returns and shall be in accordance with the latest ADA requirements.

Street Lights: (Minimum Spacing: 300 feet and at all intersections)

Materials: Refer to the most recent Sierra Pacific Power Company Details.

30 foot spun aluminum or galvanized pole with six foot arm with N-9 box.

100 W HPS Luminaire in Residential Areas.

200 W HPS Luminaire in Commercial/Industrial Areas and Arterial Streets.

Underground Service Requirements:

Residential Lots Created by the Parcel Map Procedure:

All electrical distribution facilities installed on previously undeveloped residential lots shall be installed underground. Improvements to the distribution facilities on existing residential lots which currently have underground service shall be installed underground, except in unusual situations involving short extensions of overhead facilities existing on abutting properties wherein such extensions may be approved by the City Council. Improvements to the distribution facilities on existing residential lots which currently have overhead service may be installed underground or overhead (if pre-approved by the City Engineer).

Residential Lots Created by the Subdivision Procedure:

WMC. 16.32.040: All electrical distribution facilities shall be installed underground, except in unusual situations involving short extensions of overhead facilities existing on abutting properties wherein such extensions may be approved by the City Council.

Commercial and Industrial Developments:

WMC. 17.22.070: All utilities systems must be installed underground, except in unusual situations involving short extensions of overhead systems existing on abutting properties with the prior approval by the City Council.

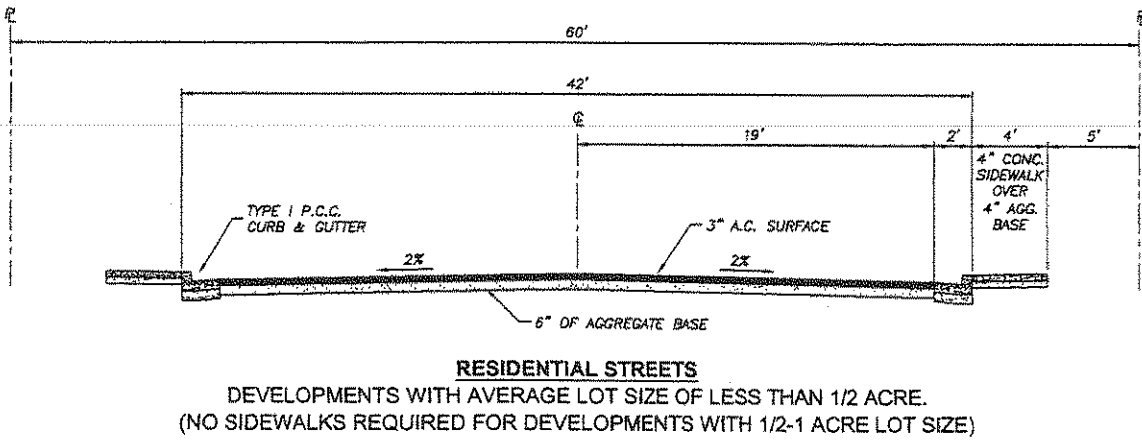
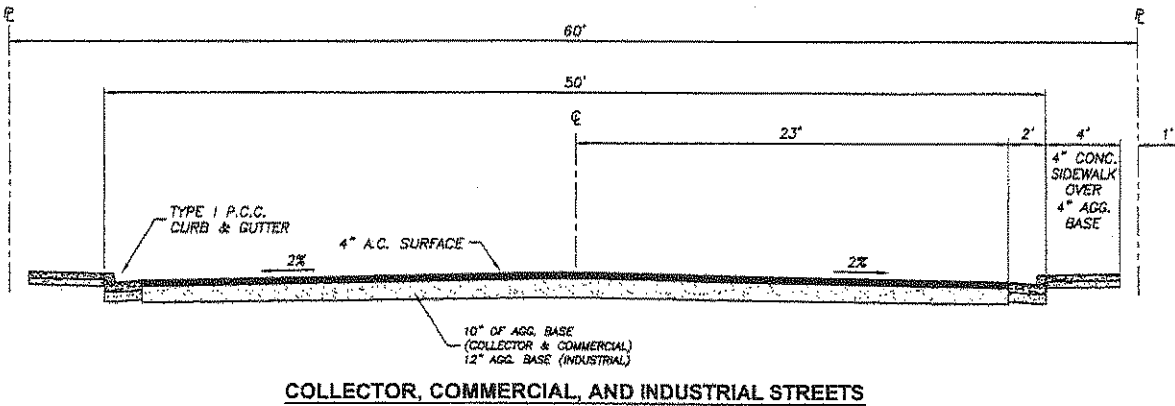
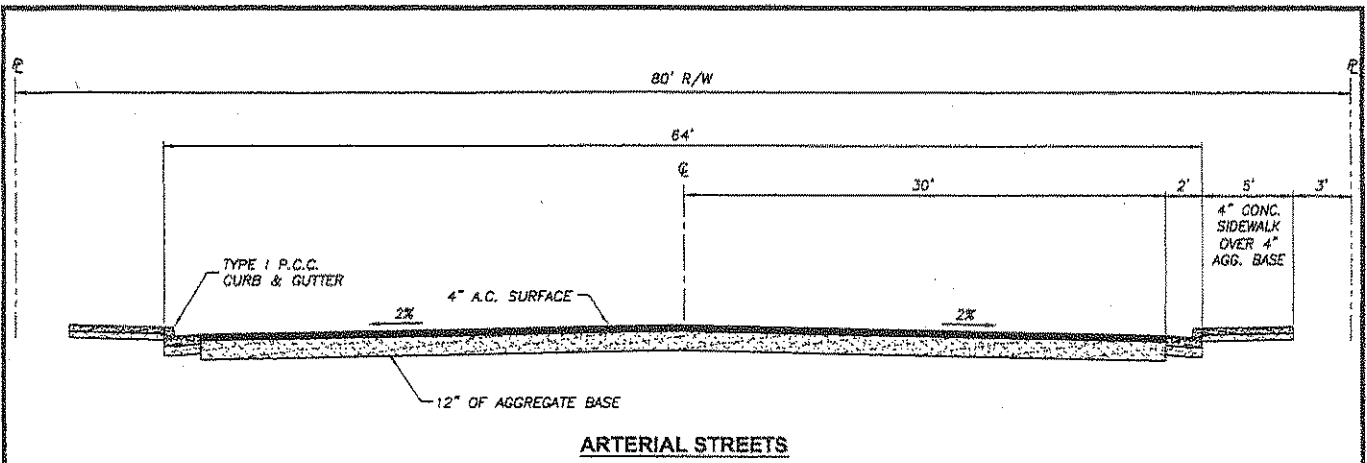

NO.	REVISION	DATE	STANDARD DETAILS FOR PUBLIC WORKS CONSTRUCTION	SECTION WINNEMUCCA
			ROADWAY SECTIONS	DRAWING NO.
				DATE
				PAGE

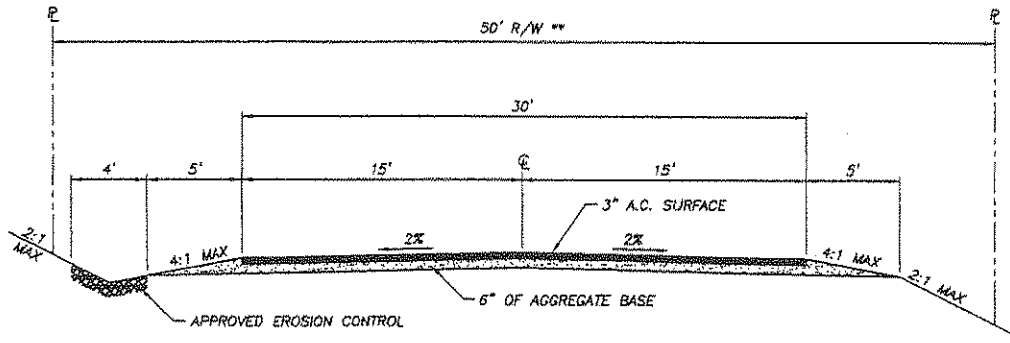

RURAL RESIDENTIAL STREETS
DEVELOPMENTS WITH AVERAGE LOT SIZE OF 1 ACRE OR LARGER

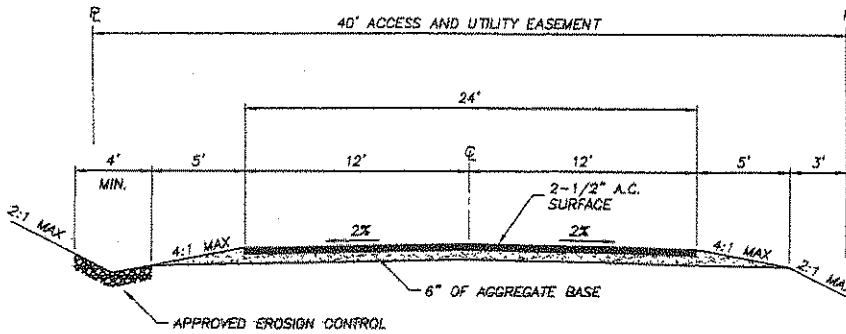

PRIVATE ACCESS ROADS
* PRIVATE ROADS SERVING 10 LOTS OR FEWER LOTS (DEAD END ONLY)

STREET SECTION NOTES

- 1) 50' RIGHT OF WAYS ALLOWED FOR RESIDENTIAL STREETS ONLY WHERE APPROVED BY THE CITY COUNCIL, WITH 10' UTILITY EASEMENTS.
- 2) STREET CROWN MAY BE MODIFIED WHERE STEEP CROSS-SLOPES EXIST, AS APPROVED BY THE CITY ENGINEER.
- 3) ARTERIAL STREETS SHALL HAVE A MORTERED BLOCK FENCE ALONG THE PROPERTY LINES AT LEAST 6' HIGH.
- 4) VALLEY GUTTERS WITH APRONS SHALL BE CONSTRUCTED WHERE DIRECTED BY THE CITY ENGINEER.

NO.	REVISION	DATE	STANDARD DETAILS FOR PUBLIC WORKS CONSTRUCTION	SECTION
			ROADWAY SECTIONS	WINNEMUCCA
				DRAWING NO.
				DATE

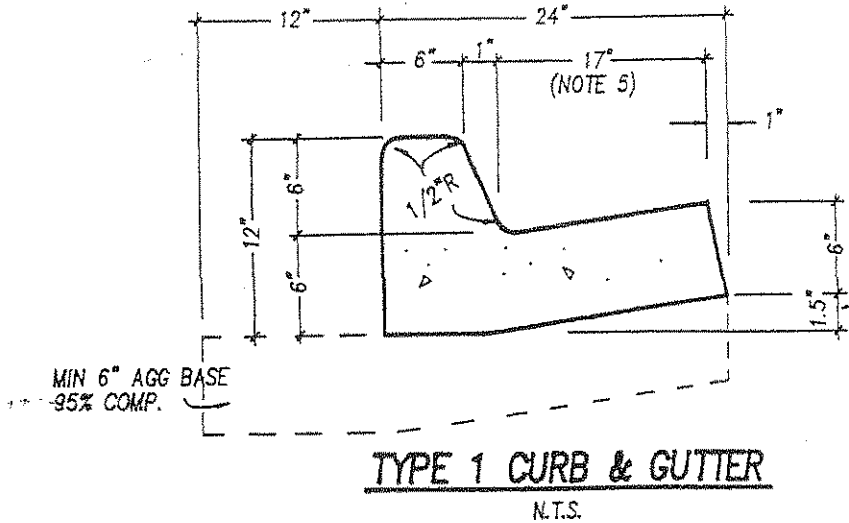

NOTES

1. ALL PCC CURB/GUTTER/SIDEWALK SHALL BE MIN 6sack OF CEMENT PER CU.YD. OF CONC UNLESS OTHERWISE SPECIFIED (4000psi) W/4.5-7.5% AIR. MAX SLUMP SHALL BE 4". MAX WATER/CEMENT RATIO SHALL BE .45
2. (a) ALL CONC CURB/GUTTER/VALLEY GUTTER SHALL HAVE WEAKENED PLANE JOINTS EVERY 10 FEET.
 (b) EXPANSION JOINTS 1/2" WIDE SHALL BE LOCATED IN CURBS & GUTTERS @ EA SIDE OF STRUCTURES, @ ENDS OF ALL CURB RETURNS, & ABUTTING HARDENED IN-PLACE CURB & GUTTER, EXCEPT THAT EXPANSION JTS. SHALL NOT BE INSTALLED WITHIN 20' OF AN ISLAND NOSE. EXPANSION JOINTS SHALL BE 1/2" THICK, SHAPED TO THE CROSS-SECTION OF THE CURB & GUTTER, & SHALL BE CONSTRUCTED @ RIGHT ANGLES TO THE CURB & GUTTER. JOINT FILLER MATERIAL SHALL CONFORM TO SECTION 202.10.
3. AGG BASE MATERIAL SHALL CONFORM TO SPECIFICATIONS FOR TYPE 2 CLASS B AGG BASE & BE COMP. TO A MIN 95% M.D.D.

NO.	REVISION	DATE	STANDARD DETAILS FOR PUBLIC WORKS CONSTRUCTION	SECTIONS
1	REDRAWN	1/95vp	TYPE 1 PCC CURB/GUTTER	1
				DRAWING NO. 1-6.1 (312)
				DATE 1/95vp PAGE 7

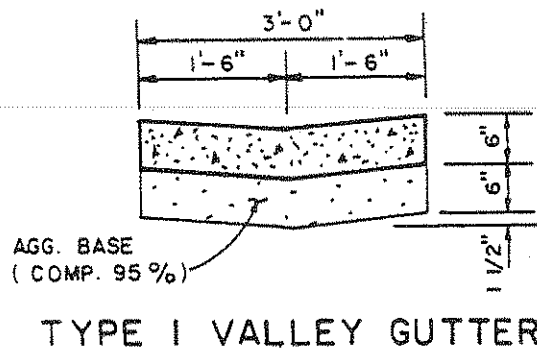
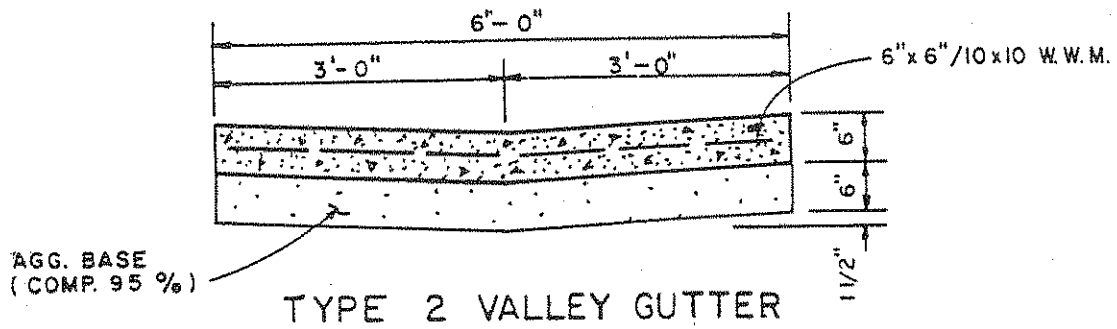

NO.	REVISION	DATE	STANDARD DETAILS FOR PUBLIC WORKS CONSTRUCTION	SECTION WINNEMUCCA	
			P.C.C. VALLEY GUTTER	DRAWING NO. WN - 4	
				DATE 3 - 91	PAGE 5

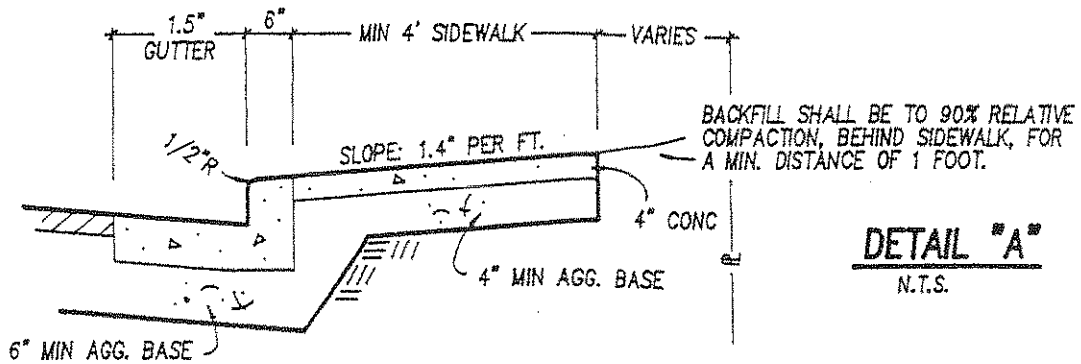
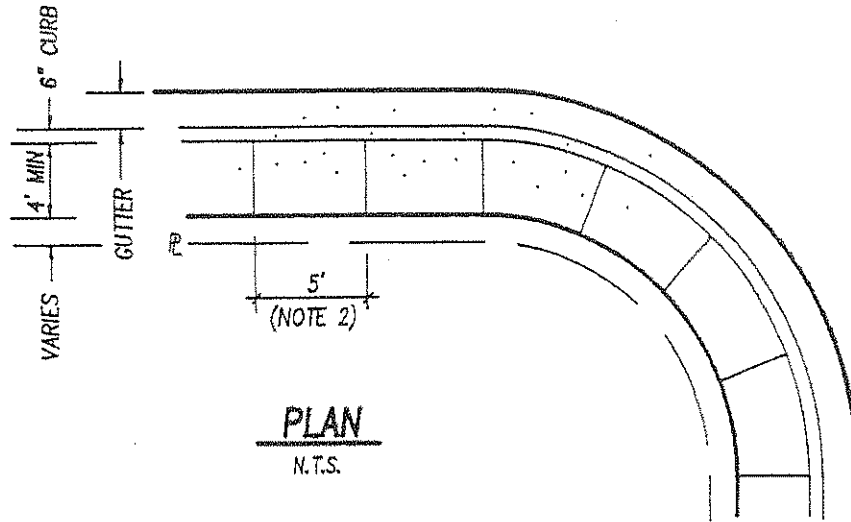

NOTES

1. MIN CURB RETURN RADIUS SHALL BE 20 FEET UNLESS OTHERWISE SPECIFIED (15' IN FALLON & RENO)
2. (a) WEAKENED PLANE JOINTS SHALL BE CONSTRUCTED IN ACCORDANCE W/DETAIL "A". (EVERY 10 FEET) IN WASHOE COUNTY, REFER TO DWG. W-16A.
(B) TRANSVERSE EXPANSION JOINTS 1/2" WIDE SHALL BE CONSTRUCTED AT ALL SIDEWALK RETURNS, OPPOSITE EXPANSION JOINTS IN ADJACENT CURB, & @ REGULAR INTERVALS NOT EXCEEDING 30'. ISOLATION JOINTS SHALL BE INSTALLED AROUND ALL STRUCTURES. EXPANSION & ISOLATION JOINTS SHALL BE FILLED W/JOINT FILLER STRIPS 1/2" THICK. JOINT MATERIAL SHALL CONFORM TO SEC.202.10.
3. ALL AGG. BASE SHALL BE TYPE 2 CLASS B. @ 95% COMPACTION
4. RENO: COLORED CONC NOT ALLOWED.
5. ON SIDEWALKS WIDER THAN 5', JOINTING PATTERN SHALL BE .8 - 1.2 TIMES THE WIDTH OF THE SIDEWALK.
6. PORTLAND CEMENT CONC (P.C.C.) SHALL HAVE THE FOLLOWING CHARACTERISTICS: 4000psi MIN COMP STRENGTH @ 28 DAYS, MIN 6 SACKS OF CEMENT PER CU.YD. W/MAX WATER-CEMENT RATIO OF 0.45, AIR ENTRAINMENT 6% ± 1.5%, SLUMP 1 TO 4 INCHES. ALL MATEIALS SHALL CONFORM TO SSPWC SEC. 202.

NO. REVISION DATE			STANDARD DETAILS FOR PUBLIC WORKS CONSTRUCTION		SECTIONS	
1	REDRAWN	1/95vp	TYPICAL SIDEWALK		1	
2	Corr Note 6	4/95vp			DRAWING NO. 1-7 (312)	
					DATE: 1/95vp	PAGE: 9

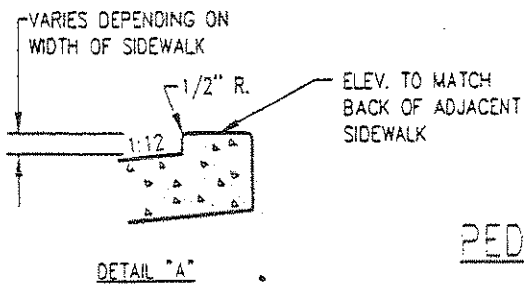
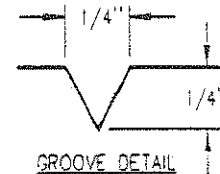
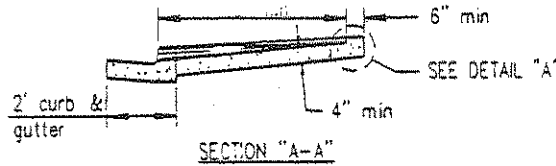
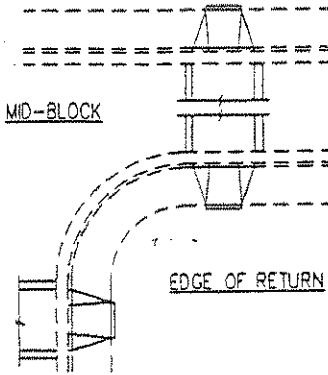
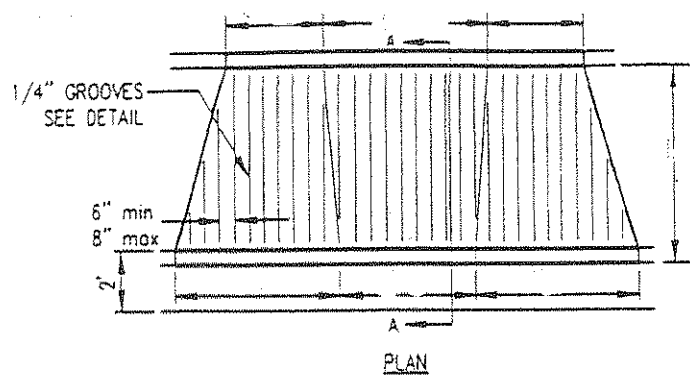
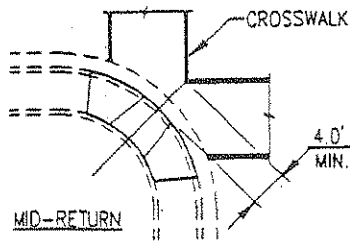

PEDESTRIAN RAMP FOR THE DISABLED
NOT TO SCALE

NOTES:

1. If obstructions such as inlets, Utility Poles, Fire Hydrants, etc. are encountered, the location and dimensions may be adjusted upon approval of the Engineer.
2. Texture to be heavy broom finish transverse to axis of ramp.
3. The mid-block ramp shown in detail shall be centered in the crosswalk.
4. Slope to meet existing conditions.
5. All ramps shall be located within crosswalks areas.
6. All concrete to be removed to sawcut or expansion joints.
7. The gutter pan - sidewalk transition section (Section A-A) will be smooth with no lip at gutter flowline. This transition section may be a monolithic pour.
8. Slope on wings at 1:12. slope on ramp from flowline to back of walk 1:12 with curb on the back side if, needed
9. If existing field conditions do not match design specifications, revisions must be pre-approved by the City.
10. Portland cement concrete (P.C.C.) shall have the following characteristics:
4000 psi min compressive strength @ 28 days, min. 6 sacks of cement per cubic yard with a max. water/cement ratio of 0.45, air entrainment 6% ± 1.5%, slump at 1 to 4 inches. All materials shall conform to SSPW Section 202.

See Page A-10 (a) for further illustrations

NO. REVISION DATE			STANDARD DETAILS FOR PUBLIC WORKS CONSTRUCTION		SECTION 1		
1	REDRAWN	8/92	PEDESTRIAN RAMP FOR THE DISABLED			DRAWING NO. 1-8 (312)	
2	REV. NOTE 7	12-92				DATE 7-81	PAGE 10
3	ADD G/N 10.	3-95					
APPROVED BY:							

Curb ramps are to be 36" minimum in width.

36" length landings are to be provided at the top of curb ramps. The landings are to be at least as wide as the curb ramp, excluding flared sides, leading to the landing.

It is difficult to change directions on a slope. Therefore, one of several options to install a curb ramp may be used.

The first figure has a flat (2%) approach onto the sidewalk, where the user can turn while on the flat surface, move up the ramp, and reach a landing at the top of the walkway.

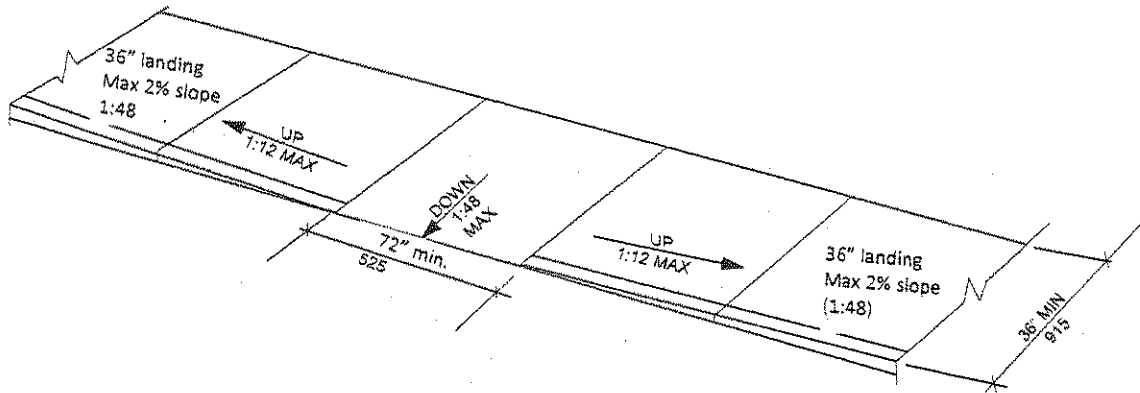

CURB RAMP OPTION

The second figure is a ramped approach (max 1:12 ramp and flared sides) onto the walkway, with the turning surface (landing) after the ramp. If this option is used (built up curb ramp) the ramp cannot project into the street, parking spaces, loading zones, etc.

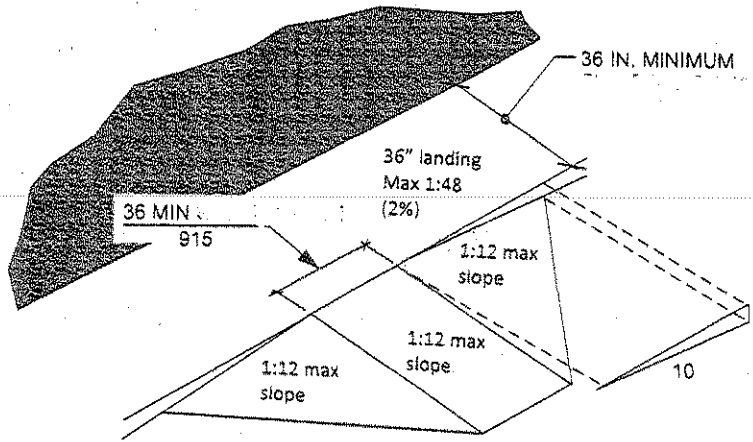

BUILT UP CURB RAMPS

Counter slopes of adjoining surfaces immediately adjacent to the curb ramp may not be steeper than 1:20. (ANSI 406)

The adjacent surfaces at transitions at curb ramps to walks, gutters and streets shall be at the same level. (ANSI 406).

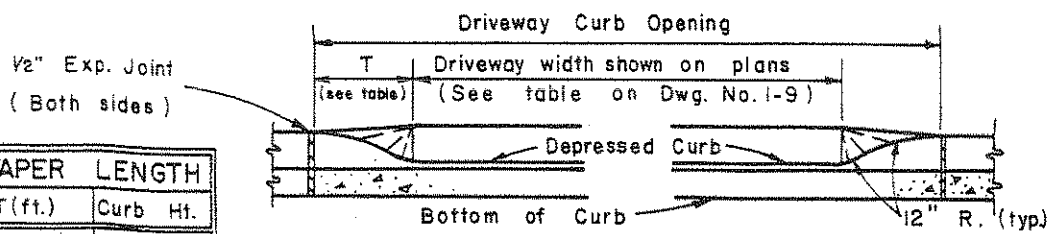
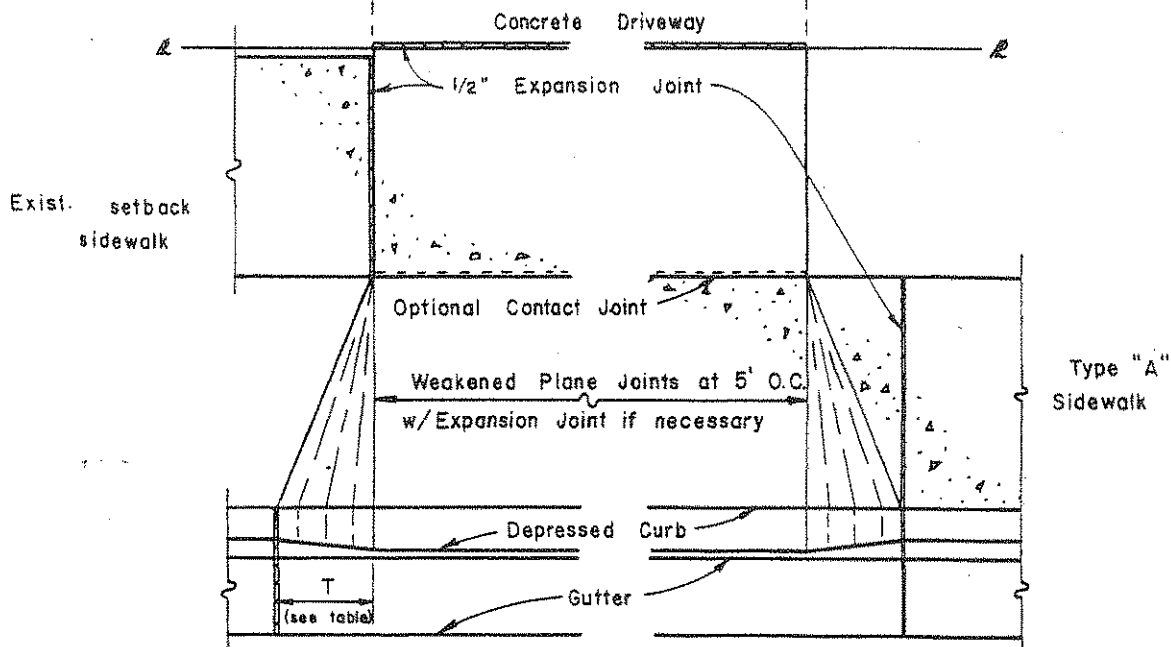

TAPER LENGTH	
T(ft.)	Curb Ht.
2.5'	≤ 5"
3.0'	6"
3.5'	7"
4.0'	8"
4.5'	≥ 9"

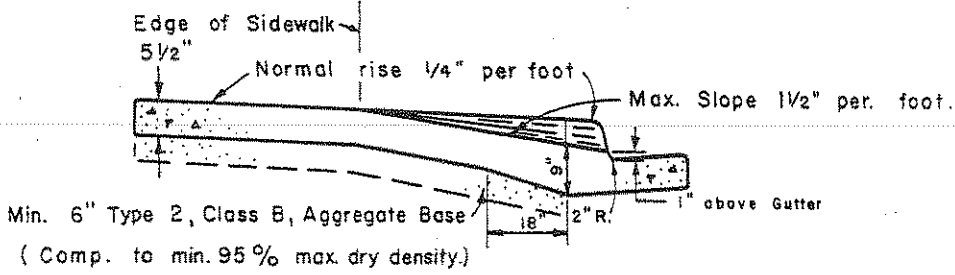

- NOTES:
1. Not approved for construction in Douglas Co. or Fallon - see Agency Section.
 2. No concrete shall be placed until forms and subgrade are inspected by the agency.
 3. Concrete shall be class AA or DA.
 4. Commercial driveways to have 6"x 6" 10/10 wire mesh extending into gutter pan.
 5. If expansion joint exists within 4 feet of driveway, remove sidewalk and curb and gutter to that joint. (or 6 sack fibermesh)
 6. Concrete removal shall be to neat sawcut lines.
 7. Remove concrete when constructing driveway where curb and gutter exist. Driveway to be monolithic to A.C. line.

NO.	REVISION	DATE	STANDARD DETAILS FOR PUBLIC WORKS CONSTRUCTION	SECTION
1	SPELLING	10-15-86	P.C.C. DRIVEWAY APRON	1
				DRAWING NO. 1-10 (312)
				DATE 7-81
				PAGE 12

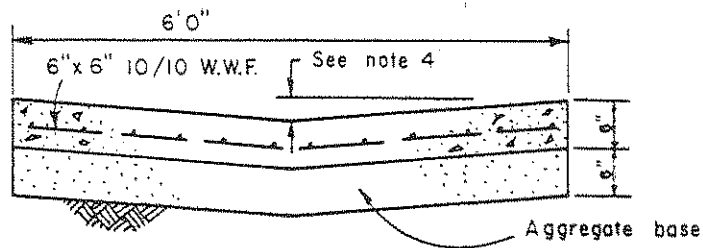
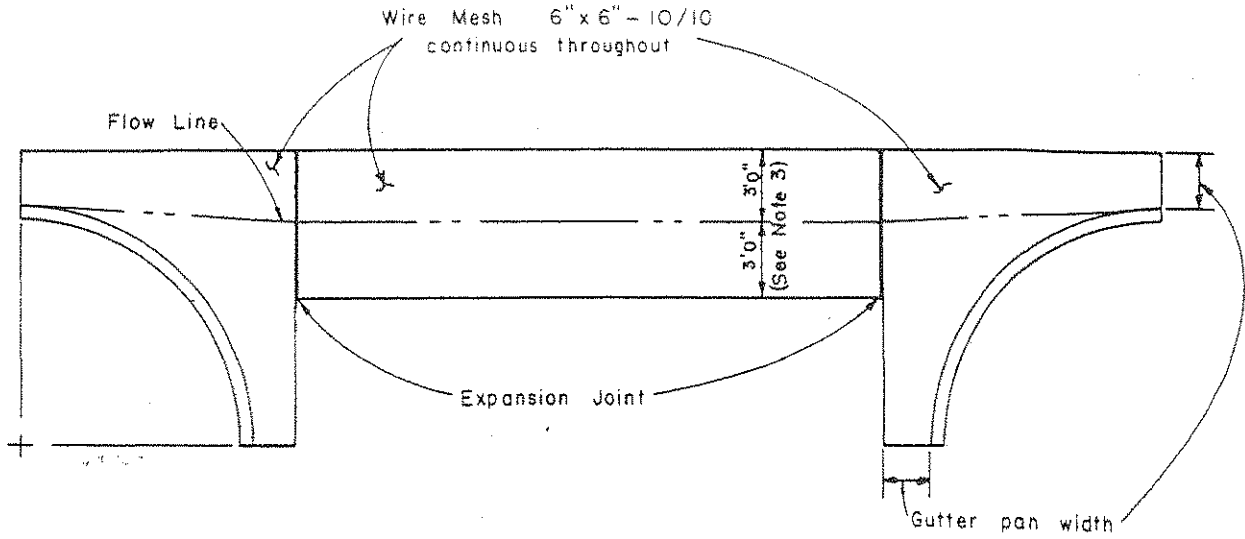

NOTES:

1. Aggregate Base shall be Type 2, Class B and be compacted to a min. 95% of max. density.
2. Portland Cement concrete shall be class AA or DA.

NO.	REVISION	DATE	STANDARD DETAILS FOR PUBLIC WORKS CONSTRUCTION	SECTION	
			P.C.C. VALLEY GUTTER	1	
				DRAWING NO.	1-15 (312)
				DATE	7-81
				PAGE	18